



# RF Power Field Effect Transistors

## N-Channel Enhancement-Mode Lateral MOSFETs

Designed for Class AB PCN and PCS base station applications with frequencies from 1900 to 2000 MHz. Suitable for CDMA, TDMA, GSM, and multicarrier amplifier applications.

- Typical CDMA Performance: 1990 MHz, 26 Volts  
 IS-95 CDMA Pilot, Sync, Paging, Traffic Codes 8 Through 13  
 Output Power — 9 Watts Avg.  
 Power Gain — 10 dB  
 Adjacent Channel Power —  
     885 kHz: -47 dBc @ 30 kHz BW  
     1.25 MHz: -55 dBc @ 12.5 kHz BW  
     2.25 MHz: -55 dBc @ 1 MHz BW
- Capable of Handling 10:1 VSWR, @ 26 Vdc, 1960 MHz, 90 Watts CW Output Power

### Features

- Internally Matched for Ease of Use
- High Gain, High Efficiency and High Linearity
- Integrated ESD Protection
- Designed for Maximum Gain and Insertion Phase Flatness
- Excellent Thermal Stability
- Characterized with Series Equivalent Large-Signal Impedance Parameters
- RoHS Compliant
- In Tape and Reel. R3 Suffix = 250 Units per 56 mm, 13 inch Reel.

**MRF19090R3**  
**MRF19090SR3**

**1930-1990 MHz, 90 W, 26 V**  
**LATERAL N-CHANNEL**  
**RF POWER MOSFETs**

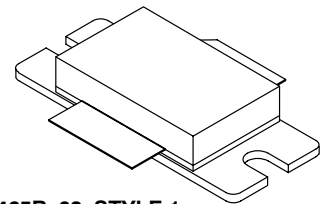

**CASE 465B-03, STYLE 1**  
**NI-880**  
**MRF19090R3**

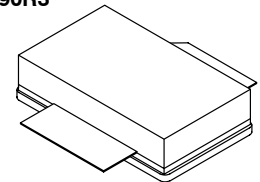

**CASE 465C-02, STYLE 1**  
**NI-880S**  
**MRF19090SR3**

**Table 1. Maximum Ratings**

Rating	Symbol	Value	Unit
Drain-Source Voltage	$V_{DSS}$	-0.5, +65	Vdc
Gate-Source Voltage	$V_{GS}$	-0.5, +15	Vdc
Total Device Dissipation @ $T_C = 25^\circ\text{C}$ Derate above $25^\circ\text{C}$	$P_D$	270 1.54	W W/ $^\circ\text{C}$
Storage Temperature Range	$T_{stg}$	- 65 to +150	$^\circ\text{C}$
Case Operating Temperature	$T_C$	150	$^\circ\text{C}$
Operating Junction Temperature	$T_J$	200	$^\circ\text{C}$

**Table 2. Thermal Characteristics**

Characteristic	Symbol	Value	Unit
Thermal Resistance, Junction to Case	$R_{\theta JC}$	0.65	$^\circ\text{C}/\text{W}$

**Table 3. ESD Protection Characteristics**

Test Conditions	Class
Human Body Model	1 (Minimum)
Machine Model	M3 (Minimum)

**Table 4. Electrical Characteristics** ( $T_C = 25^\circ\text{C}$  unless otherwise noted)

Characteristic	Symbol	Min	Typ	Max	Unit
<b>Off Characteristics</b>					
Drain-Source Breakdown Voltage ( $V_{GS} = 0\text{ Vdc}$ , $I_D = 100\ \mu\text{A}$ )	$V_{(BR)DSS}$	65	—	—	Vdc
Zero Gate Voltage Drain Current ( $V_{DS} = 28\text{ Vdc}$ , $V_{GS} = 0\text{ Vdc}$ )	$I_{DSS}$	—	—	10	$\mu\text{Adc}$
Gate-Source Leakage Current ( $V_{GS} = 5\text{ Vdc}$ , $V_{DS} = 0\text{ Vdc}$ )	$I_{GSS}$	—	—	1	$\mu\text{Adc}$
<b>On Characteristics</b>					
Forward Transconductance ( $V_{DS} = 10\text{ Vdc}$ , $I_D = 3\text{ Adc}$ )	$g_{fs}$	—	7.2	—	S
Gate Threshold Voltage ( $V_{DS} = 10\text{ Vdc}$ , $I_D = 300\ \mu\text{Adc}$ )	$V_{GS(th)}$	2.0	—	4.0	Vdc
Gate Quiescent Voltage ( $V_{DS} = 26\text{ Vdc}$ , $I_D = 750\text{ mAdc}$ )	$V_{GS(Q)}$	2.5	3.8	4.5	Vdc
Drain-Source On-Voltage ( $V_{GS} = 10\text{ Vdc}$ , $I_D = 1\text{ Adc}$ )	$V_{DS(on)}$	—	0.10	—	Vdc
<b>Dynamic Characteristics</b>					
Reverse Transfer Capacitance (1) ( $V_{DS} = 26\text{ Vdc}$ , $V_{GS} = 0$ , $f = 1\text{ MHz}$ )	$C_{rss}$	—	4.2	—	pF
<b>Functional Tests (In Freescale Test Fixture)</b>					
Two-Tone Common-Source Amplifier Power Gain ( $V_{DD} = 26\text{ Vdc}$ , $P_{out} = 90\text{ W PEP}$ , $I_{DQ} = 750\text{ mA}$ , $f = 1930\text{ MHz}$ and $1990\text{ MHz}$ , Tone Spacing = $100\text{ kHz}$ )	$G_{ps}$	10	11.5	—	dB
Two-Tone Drain Efficiency ( $V_{DD} = 26\text{ Vdc}$ , $P_{out} = 90\text{ W PEP}$ , $I_{DQ} = 750\text{ mA}$ , $f = 1930\text{ MHz}$ and $1990\text{ MHz}$ , Tone Spacing = $100\text{ kHz}$ )	$\eta$	33	35	—	%
3rd Order Intermodulation Distortion ( $V_{DD} = 26\text{ Vdc}$ , $P_{out} = 90\text{ W PEP}$ , $I_{DQ} = 750\text{ mA}$ , $f = 1930\text{ MHz}$ and $1990\text{ MHz}$ , Tone Spacing = $100\text{ kHz}$ )	IMD	—	-30	-28	dBc
Input Return Loss ( $V_{DD} = 26\text{ Vdc}$ , $P_{out} = 90\text{ W PEP}$ , $I_{DQ} = 750\text{ mA}$ , $f = 1930\text{ MHz}$ and $1990\text{ MHz}$ , Tone Spacing = $100\text{ kHz}$ )	IRL	—	-12	—	dB
$P_{out, 1\text{ dB}}$ Compression Point ( $V_{DD} = 26\text{ Vdc}$ , $P_{out} = 90\text{ W CW}$ , $f = 1990\text{ MHz}$ )	P1dB	—	90	—	W

1. Part is internally matched both on input and output.

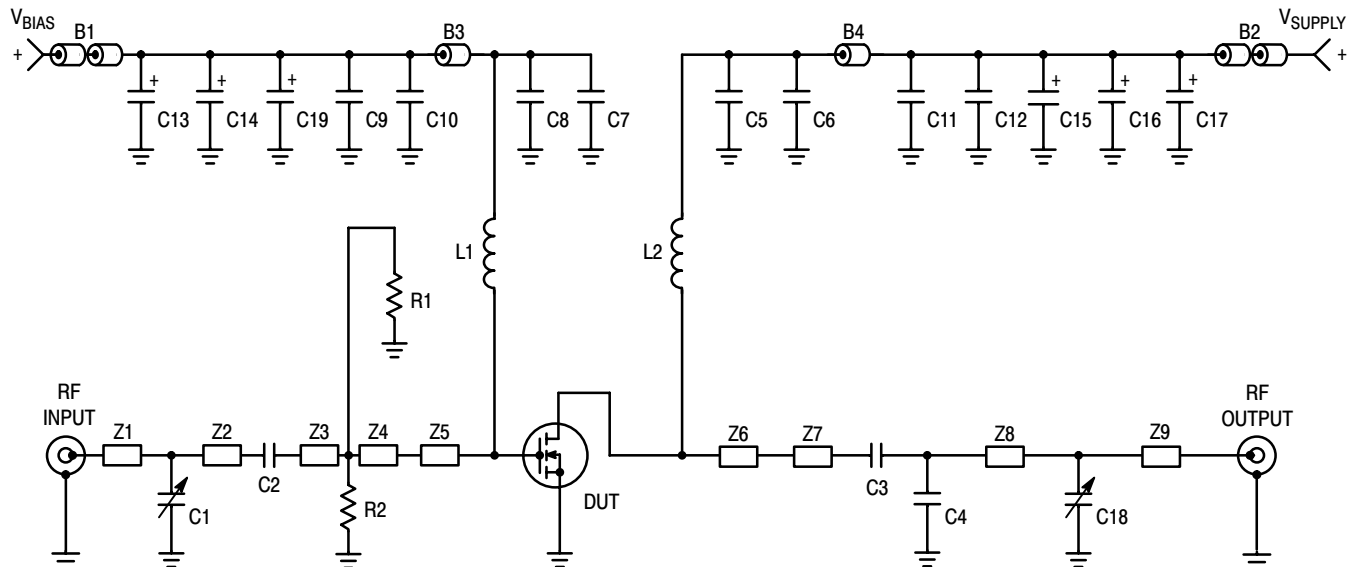

B1, B2	2 Ferrite Beads, Round, Ferroxcube #56-590-65-3B	L1, L2	8 Turns, #26 AWG, 0.085" OD, 0.330" Long, Copper Wire
B3, B34	Ferrite Beads, Surface Mount, Ferroxcube	R1, R2	270 $\Omega$ , 1/4 W Chip Resistors, Garrett Instruments #RM73B2B271JT
C1, C18	0.4 - 2.5 pF Variable Capacitors, Johanson Gigatrim #27285	Z1	ZO = 50 Ohms
C2, C5, C8	10 pF Chip Capacitors, ATC #100B100CCA500X	Z2	ZO = 50 Ohms, Lambda = 0.123
C3	12 pF Chip Capacitor, ATC #100B120CCA500X	Z3	ZO = 15.24 Ohms, Lambda = 0.0762
C4	0.3 pF Chip Capacitor, ATC #100B0R3CCA500X	Z4	ZO = 10.11 Ohms, Lambda = 0.0392
C6, C7	120 pF Chip Capacitors, ATC #100B12R1CCA500X	Z5	ZO = 6.34 Ohms, Lambda = 0.0711
C9, C12	0.1 $\mu$ F Chip Capacitors, Kemet #CDR33BX104AKWS	Z6	ZO = 5.02 Ohms, Lambda = 0.0476
C10, C11	1000 pF Chip Capacitors, ATC #100B102JCA50X	Z7	ZO = 5.54 Ohms, Lambda = 0.0972
C13, C17	22 $\mu$ F, 35 V Tantalum Chip Capacitors, Kemet #T491X226K035AS4394	Z8	ZO = 50.0 Ohms, Lambda = 0.194
C14, C16	10 $\mu$ F, 35 V Tantalum Chip Capacitors, Kemet #T495X106K035AS4394	Z9	ZO = 50.0 Ohms
C15, C19	1 $\mu$ F, 35 V Tantalum Chip Capacitors, Kemet #T495X105K035AS4394	Raw PCB Material	0.030" Glass Teflon <sup>®</sup> , $\epsilon_r = 2.55$ , 2 oz Copper, 3" x 5" Dimensions

Figure 1. MRF19090 Test Circuit Schematic

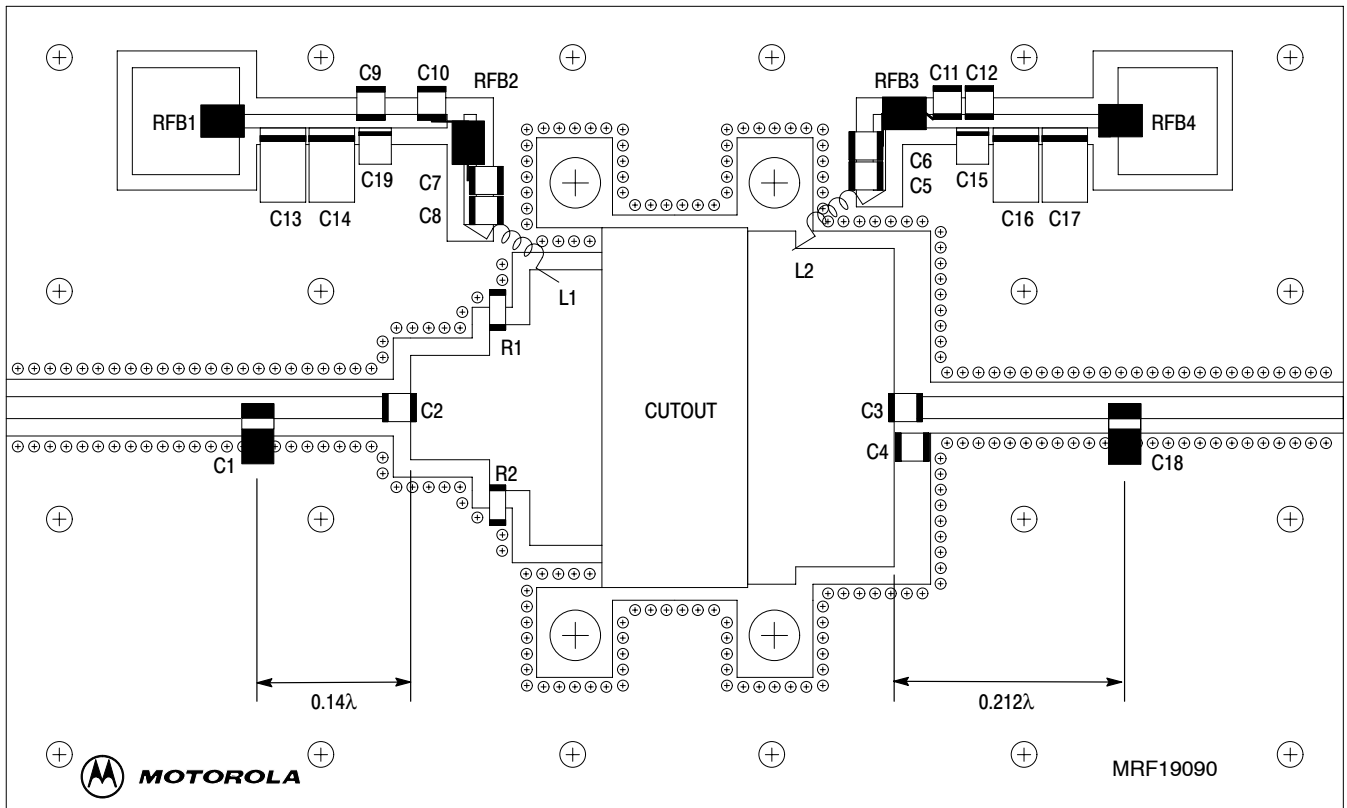

Freescall has begun the transition of marking Printed Circuit Boards (PCBs) with the Freescall Semiconductor signature/logo. PCBs may have either Motorola or Freescall markings during the transition period. These changes will have no impact on form, fit or function of the current product.

**Figure 2. MRF19090 Test Circuit Component Layout**

## TYPICAL CHARACTERISTICS

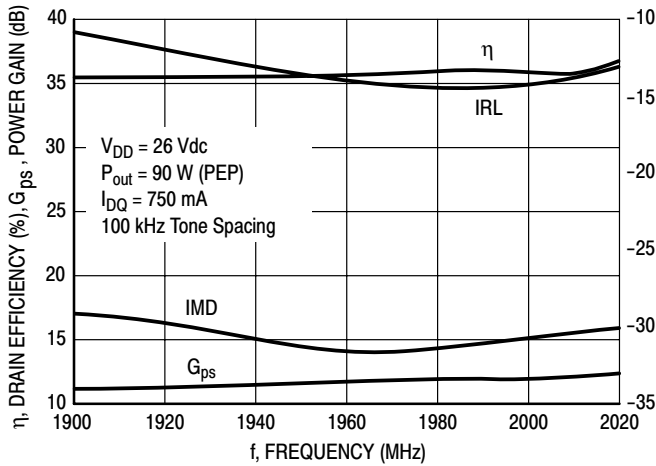

Figure 3. Class AB Performance versus Frequency

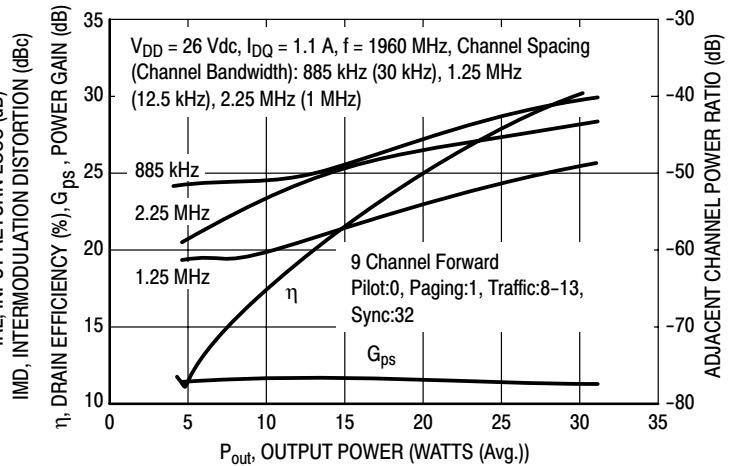

Figure 4. CDMA Performance ACPR, Gain and Drain Efficiency versus Output Power

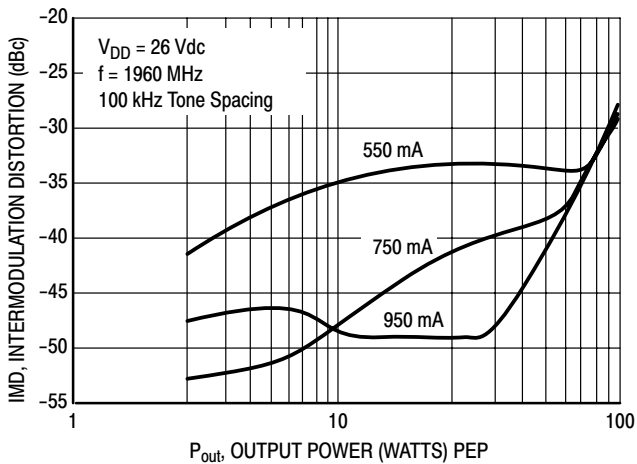

Figure 5. Third Order Intermodulation Distortion versus Output Power

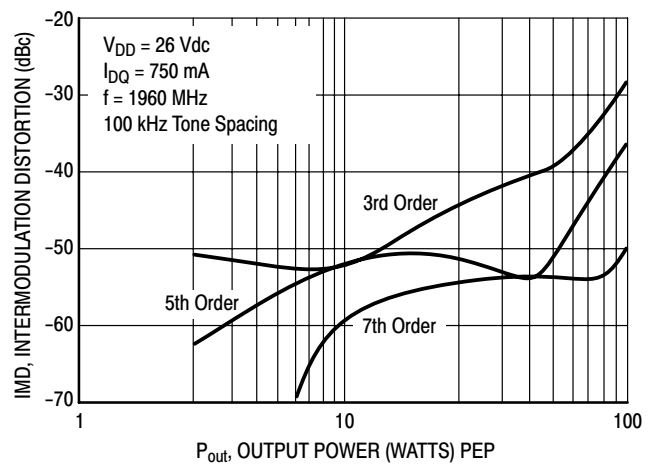

Figure 6. Intermodulation Products versus Output Power

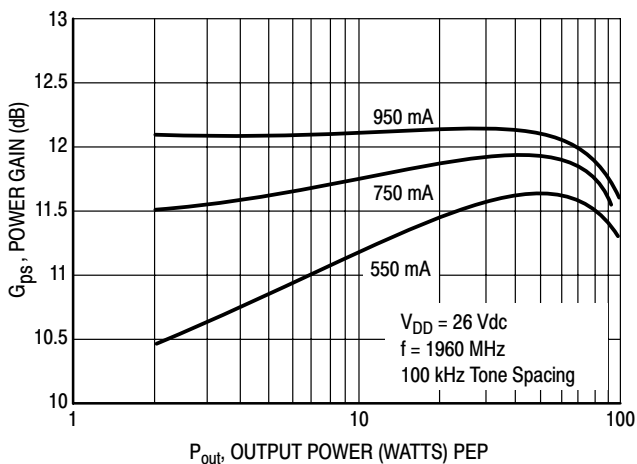

Figure 7. Power Gain versus Output Power

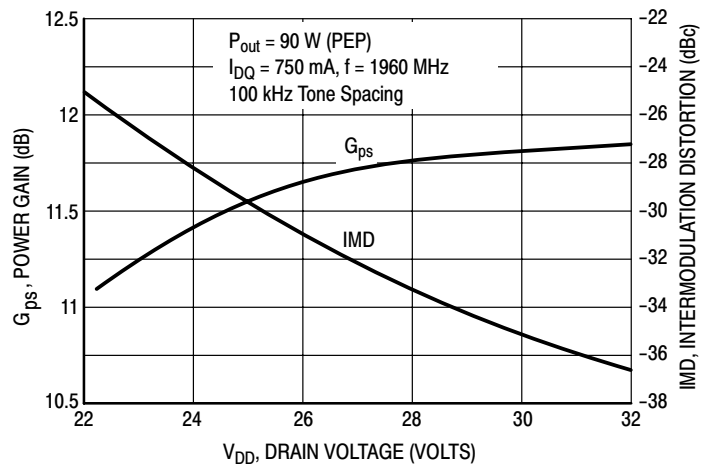
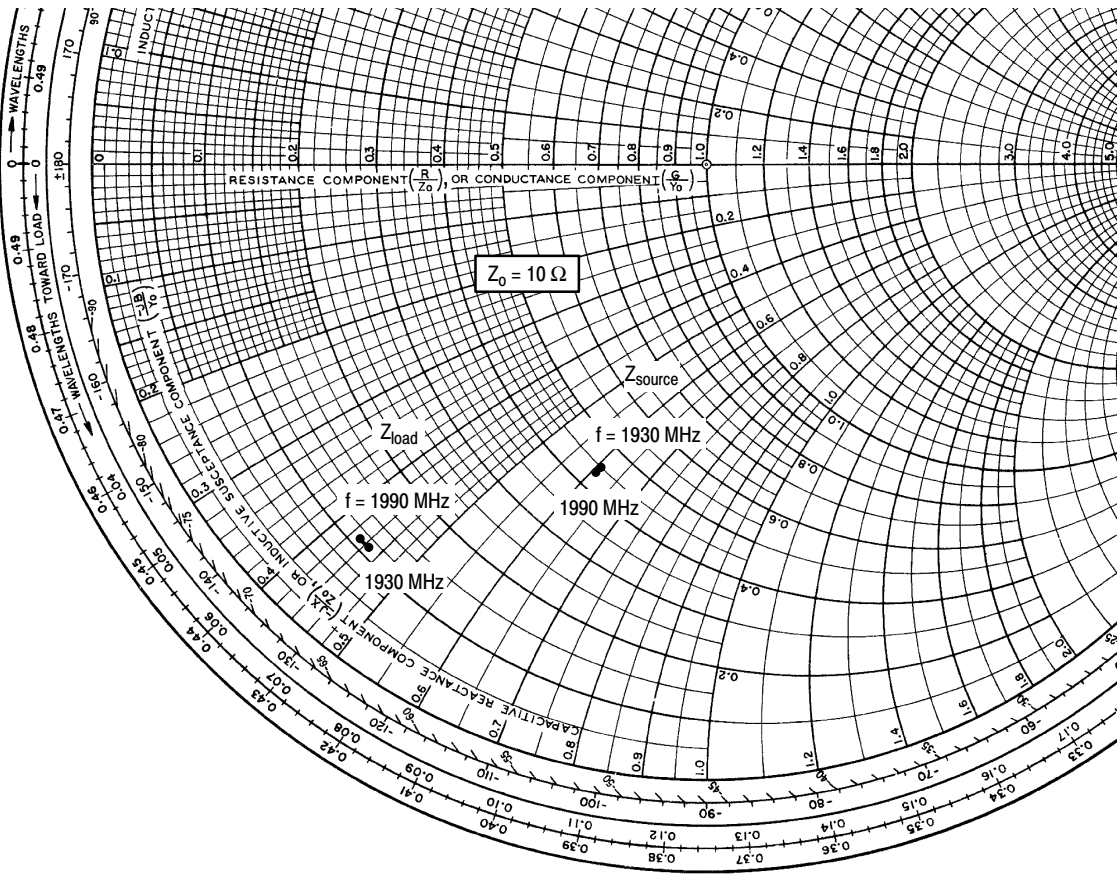

Figure 8. Third Order Intermodulation Distortion and Gain versus Supply Voltage



$V_{DD} = 26\text{ V}$ ,  $I_{DQ} = 750\text{ mA}$ ,  $P_{out} = 90\text{ Watts (PEP)}$

f MHz	$Z_{source}$ $\Omega$	$Z_{load}$ $\Omega$
1930	$4.5 - j6.1$	$1.1 - j4.5$
1960	$4.4 - j6.0$	$1.1 - j4.4$
1990	$4.3 - j6.1$	$1.1 - j4.3$

$Z_{source}$  = Test circuit impedance as measured from gate to ground.

$Z_{load}$  = Test circuit impedance as measured from drain to ground.

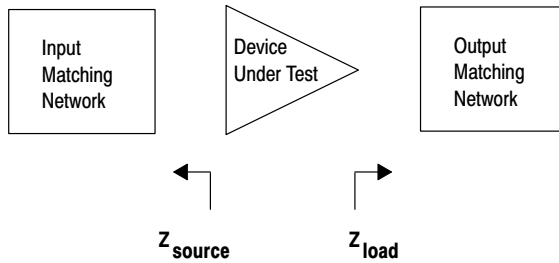
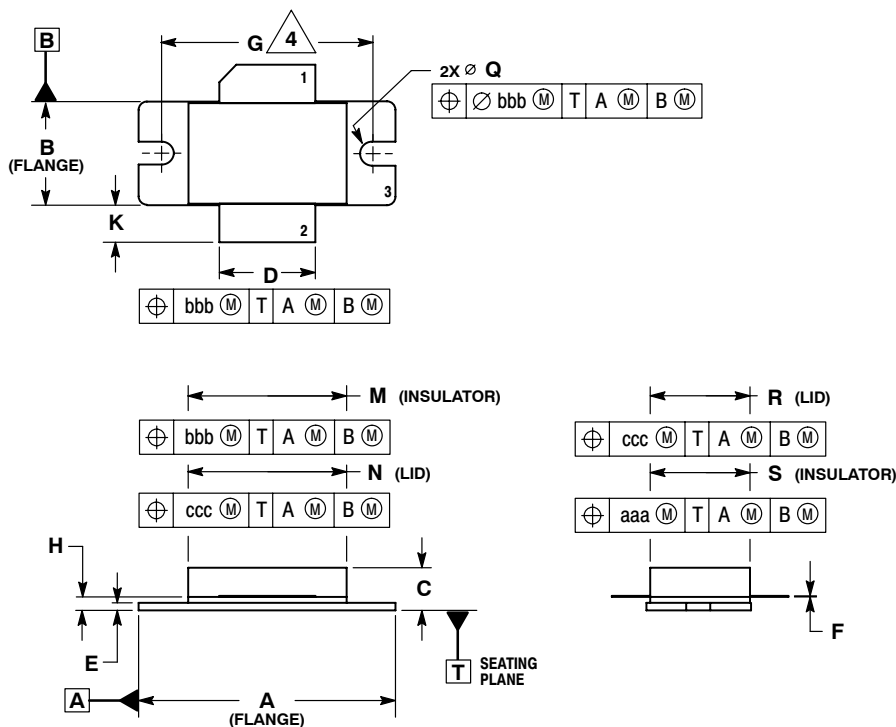

Figure 9. Series Equivalent Source and Load Impedance

## PACKAGE DIMENSIONS



- NOTES:
1. DIMENSIONING AND TOLERANCING PER ANSI Y14.5M-1994.
  2. CONTROLLING DIMENSION: INCH.
  3. DIMENSION H IS MEASURED 0.030 (0.762) AWAY FROM PACKAGE BODY.
  4. RECOMMENDED BOLT CENTER DIMENSION OF 1.16 (29.57) BASED ON M3 SCREW.

DIM	INCHES		MILLIMETERS	
	MIN	MAX	MIN	MAX
A	1.335	1.345	33.91	34.16
B	0.535	0.545	13.6	13.8
C	0.147	0.200	3.73	5.08
D	0.495	0.505	12.57	12.83
E	0.035	0.045	0.89	1.14
F	0.003	0.006	0.08	0.15
G	1.100 BSC		27.94 BSC	
H	0.057	0.067	1.45	1.70
K	0.175	0.205	4.44	5.21
M	0.872	0.888	22.15	22.55
N	0.871	0.889	19.30	22.60
Q	$\varnothing .118$	$\varnothing .138$	$\varnothing 3.00$	$\varnothing 3.51$
R	0.515	0.525	13.10	13.30
S	0.515	0.525	13.10	13.30
aaa	0.007 REF		0.178 REF	
bbb	0.010 REF		0.254 REF	
ccc	0.015 REF		0.381 REF	

- STYLE 1:  
 PIN 1. DRAIN  
 2. GATE  
 3. SOURCE

**CASE 465B-03  
 ISSUE D  
 NI-880  
 MRF19090R3**

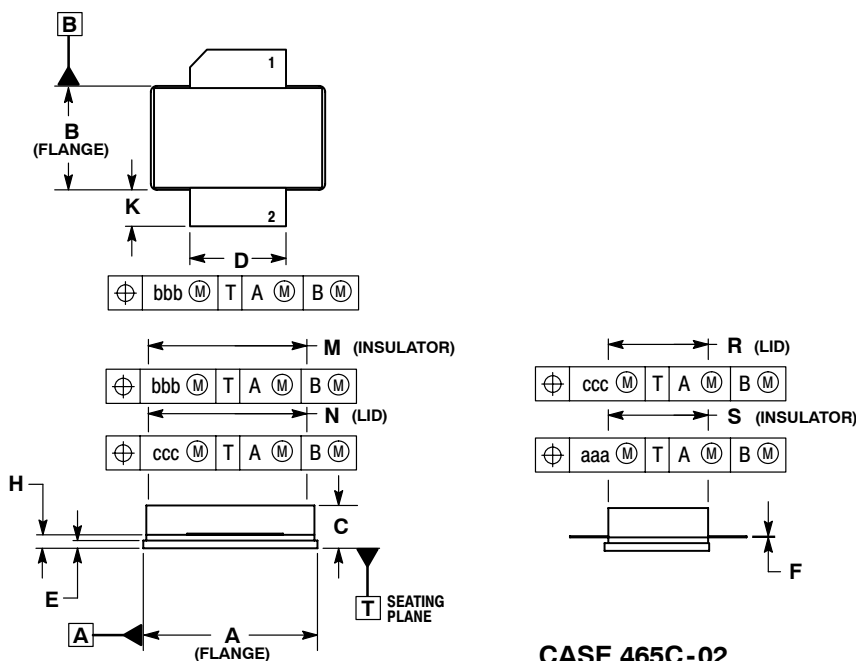

- NOTES:
1. DIMENSIONING AND TOLERANCING PER ANSI Y14.5M-1994.
  2. CONTROLLING DIMENSION: INCH.
  3. DIMENSION H IS MEASURED 0.030 (0.762) AWAY FROM PACKAGE BODY.

DIM	INCHES		MILLIMETERS	
	MIN	MAX	MIN	MAX
A	0.905	0.915	22.99	23.24
B	0.535	0.545	13.60	13.80
C	0.147	0.200	3.73	5.08
D	0.495	0.505	12.57	12.83
E	0.035	0.045	0.89	1.14
F	0.003	0.006	0.08	0.15
H	0.057	0.067	1.45	1.70
K	0.170	0.210	4.32	5.33
M	0.872	0.888	22.15	22.55
N	0.871	0.889	19.30	22.60
R	0.515	0.525	13.10	13.30
S	0.515	0.525	13.10	13.30
aaa	0.007 REF		0.178 REF	
bbb	0.010 REF		0.254 REF	
ccc	0.015 REF		0.381 REF	

- STYLE 1:  
 PIN 1. DRAIN  
 2. GATE  
 3. SOURCE

**CASE 465C-02  
 ISSUE D  
 NI-880S  
 MRF19090SR3**

**MRF19090R3 MRF19090SR3**

## **How to Reach Us:**

### **Home Page:**

www.freescale.com

### **E-mail:**

support@freescale.com

### **USA/Europe or Locations Not Listed:**

Freescale Semiconductor  
Technical Information Center, CH370  
1300 N. Alma School Road  
Chandler, Arizona 85224  
+1-800-521-6274 or +1-480-768-2130  
support@freescale.com

### **Europe, Middle East, and Africa:**

Freescale Halbleiter Deutschland GmbH  
Technical Information Center  
Schatzbogen 7  
81829 Muenchen, Germany  
+44 1296 380 456 (English)  
+46 8 52200080 (English)  
+49 89 92103 559 (German)  
+33 1 69 35 48 48 (French)  
support@freescale.com

### **Japan:**

Freescale Semiconductor Japan Ltd.  
Headquarters  
ARCO Tower 15F  
1-8-1, Shimo-Meguro, Meguro-ku,  
Tokyo 153-0064  
Japan  
0120 191014 or +81 3 5437 9125  
support.japan@freescale.com

### **Asia/Pacific:**

Freescale Semiconductor Hong Kong Ltd.  
Technical Information Center  
2 Dai King Street  
Tai Po Industrial Estate  
Tai Po, N.T., Hong Kong  
+800 2666 8080  
support.asia@freescale.com

### **For Literature Requests Only:**

Freescale Semiconductor Literature Distribution Center  
P.O. Box 5405  
Denver, Colorado 80217  
1-800-441-2447 or 303-675-2140  
Fax: 303-675-2150  
LDCForFreescaleSemiconductor@hibbertgroup.com

Information in this document is provided solely to enable system and software implementers to use Freescale Semiconductor products. There are no express or implied copyright licenses granted hereunder to design or fabricate any integrated circuits or integrated circuits based on the information in this document.

Freescale Semiconductor reserves the right to make changes without further notice to any products herein. Freescale Semiconductor makes no warranty, representation or guarantee regarding the suitability of its products for any particular purpose, nor does Freescale Semiconductor assume any liability arising out of the application or use of any product or circuit, and specifically disclaims any and all liability, including without limitation consequential or incidental damages. "Typical" parameters that may be provided in Freescale Semiconductor data sheets and/or specifications can and do vary in different applications and actual performance may vary over time. All operating parameters, including "Typicals", must be validated for each customer application by customer's technical experts. Freescale Semiconductor does not convey any license under its patent rights nor the rights of others. Freescale Semiconductor products are not designed, intended, or authorized for use as components in systems intended for surgical implant into the body, or other applications intended to support or sustain life, or for any other application in which the failure of the Freescale Semiconductor product could create a situation where personal injury or death may occur. Should Buyer purchase or use Freescale Semiconductor products for any such unintended or unauthorized application, Buyer shall indemnify and hold Freescale Semiconductor and its officers, employees, subsidiaries, affiliates, and distributors harmless against all claims, costs, damages, and expenses, and reasonable attorney fees arising out of, directly or indirectly, any claim of personal injury or death associated with such unintended or unauthorized use, even if such claim alleges that Freescale Semiconductor was negligent regarding the design or manufacture of the part.

Freescale™ and the Freescale logo are trademarks of Freescale Semiconductor, Inc. All other product or service names are the property of their respective owners.  
© Freescale Semiconductor, Inc. 2006. All rights reserved.

